



EUROPA DESIGNER STONE



WE'VE BUILT OUR REPUTATION BLOCK BY BLOCK



EUROPA DESIGNER STONE



CASTELLO



LAZIO

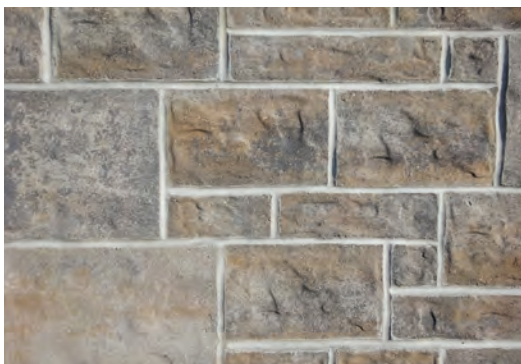

MIRANDA

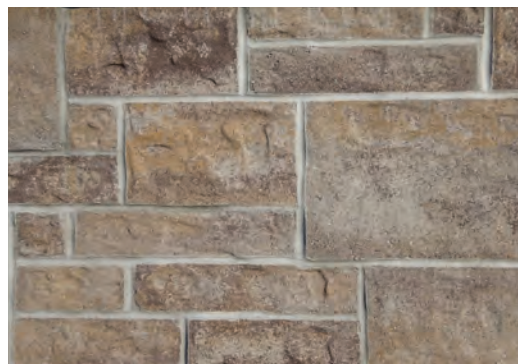

PESCARA



RUSTICO

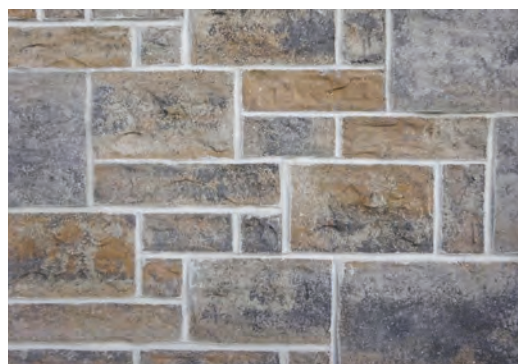

TERRA

A BOLD, NEW LOOK. THE DISTINCTIVE MANUFACTURED STONE FACE ADDS AN ARCHITECTURAL ELEGANCE TO ANY PROJECT, WHILE PROVIDING THE ADVANTAGES OF UNIT MASONRY IN A MODULAR SCALE. IDEAL FOR USE AS EITHER THE MAIN WALL FIELD OR MIXED WITH ANY NUMBER OF OUR COMPLEMENTARY PRODUCTS.

- ALL STONE PRODUCTS PRODUCED IN ACCORDANCE TO CSA STANDARDS
- EUROPA STONE COMPLEMENTS A VARIETY OF BRICK SIZES
- LEED COMPLIANCE

COMBINATIONS

100% COMBO

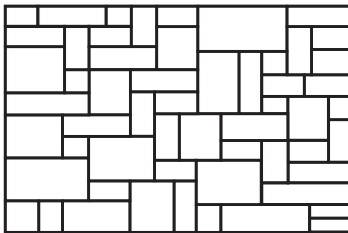

60% COMBO / 40% OF LARGE

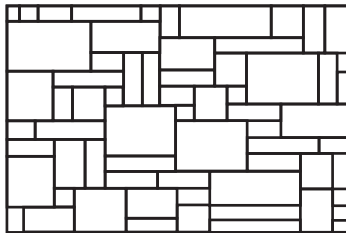

90% COMBO / 10% OF LARGE

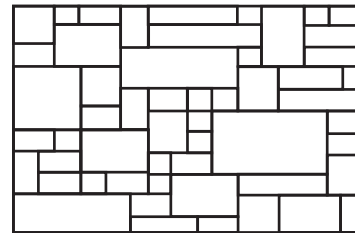

50% COMBO / 50% OF LARGE

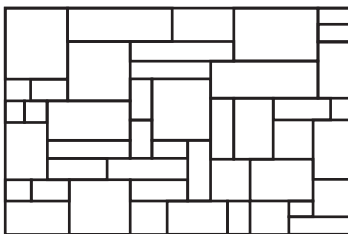

75% COMBO / 25% OF LARGE

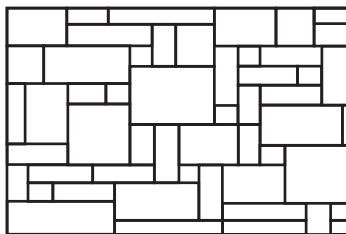

NOTE: COVERAGE PER CUBE
80 SQUARE FEET
(7.43 SQUARE METERS)

SIZES

COMBO

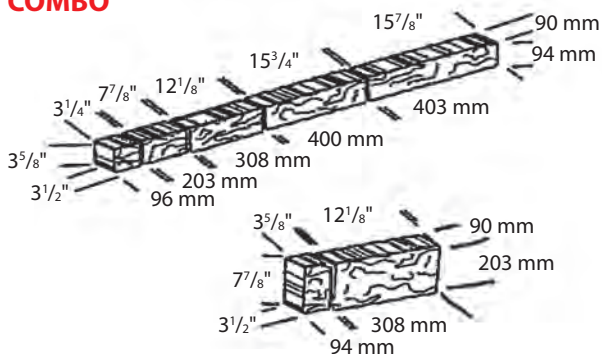

LARGE

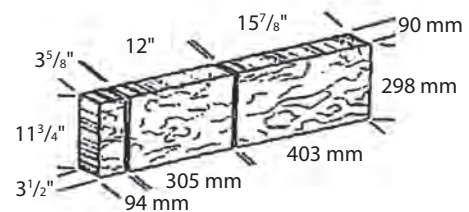



OUR OFFICE LOCATIONS

GORMLEY - HEAD OFFICE

5 CARDICO DRIVE GORMLEY, ON L0H 1G0

OFFICE: 416.213.7444

ORDER DESK: 416.213.7447

TOLL FREE: 1.877.792.5625

FAX: 416.213.7441

LONDON

1298 CLARKE ROAD LONDON, ON N5V 3B5

OFFICE: 519.455.4741

ORDER DESK: 1.800.265.1592

TOLL FREE: 1.877.792.5625

FAX: 519.453.0732

OUR MARKET-LEADING PRODUCTS ARE DISTRIBUTED THROUGHOUT CANADA AND THE UNITED STATES

RICHVALEYORK.COM